

# 2025

# ottobock.

## Lightweight wheelchair *Start<sup>M4</sup> XXL.*

Quotation

Order

### Billing Address

PO no.

Cust Name

Street no.

PC, County

### Shipping address (if different from billing address)

Cust Name

Street no.

PC, County

Name \_\_\_\_\_ Date \_\_\_\_\_ Signature \_\_\_\_\_



## Base Price - £1110.00

Please email all orders to  
[Ottobockmobility@ottobock.com](mailto:Ottobockmobility@ottobock.com)

Valid from 01.01.2025 to 31.12.25

By placing the order, you agree to comply with the instructions for use/service manuals for accessories and products of other manufacturers when combining them with an Ottobock product, in addition to the instructions for use/service manuals of the respective Ottobock products. Also you confirm to have read, understood and accepted, our general terms and conditions. In addition, you agree, upon placing an order, to conduct your own conformity assessment or approval in accordance with national requirements if and when you implement modifications or attachments that do not meet the specifications of Ottobock instructions for use/service manuals. Wheelchairs with CLT package cannot be returned or exchanged

### Standard equipment selection (unless alternative option selected)

Article number: 480F53=40000\_K

- Aluminium tube frame with double crossbrace
- Tip-assist integrated into the frame
- Individual leg supports, angle-adjustable, plastic foot plates
- Swing-away leg support holders
- Side panel with arm support, height-adjustable
- Nylon seat and back support upholstery, black
- Modular design
- Drive wheels with reinforced spokes and quickrelease axles
- Knee lever wheel lock
- Back support tube with lumbar curve, reinforced
- Different back support height setting options from 40 – 47.5 cm
- Weight: from 17.5 kg

**folding, max. user weight 160 kg/353 lbs**

The number codes contained in this order form are not intended to be used as article numbers for spare parts orders.  
Please scan the QR code to access the spare parts catalogue for any spare parts orders.



## Lightweight wheelchair *Start<sup>M4</sup> XXL.*

### Wheelchair measurements

- 1 Anterior seat height (ASH) = ground to top of seat upholstery
- 2 Lower leg length (LL) = top of seat upholstery to top of foot plate (without seat cushion)
- 3 Posterior seat height (PSH)= ground to top of seat upholstery
- 4 Back support height (BH)= top of seat tube (cross-brace) to top of back support upholster
- 5 Seat depth (SD) = front of seat upholstery to back support tube
- 6 Seat width (SW) = outside edge of frame tube to outside edge of frame tube

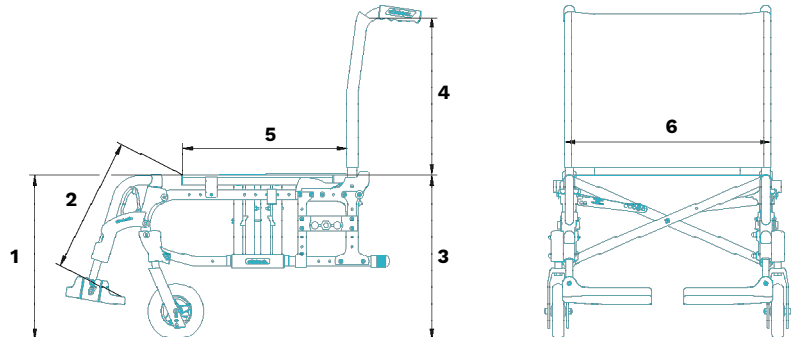

### Wheelchair measurements

1 Anterior seat height (aSH)  cm

2 Lower leg length (LL)  cm

3 Posterior seat height (pSH)  cm

4 Back support height (RH)  cm

5 Seat depth (SD) in cm  cm

6 Seat width (SW)  cm

<sup>1</sup> This information will help to support user-oriented settings. Ottobock guarantees the confidential and purely internal use of these data. A manufacturing tolerance of 5 mm applies to all measurements.

#### Seat width (SW) in cm

43    45,5    48    50,5    53    55,5    58

#### Seat depth (SD) in cm

43    46    49

#### Anterior seat height (aSH) in cm

40    41    42    43    44    45    46    47    48    49    50    51

#### Posterior seat height (pSH) in cm

38    41    44    47    50

## Lightweight wheelchair *Start<sup>M4</sup> XXL.*

### Information

#### Horizontal drive wheel position

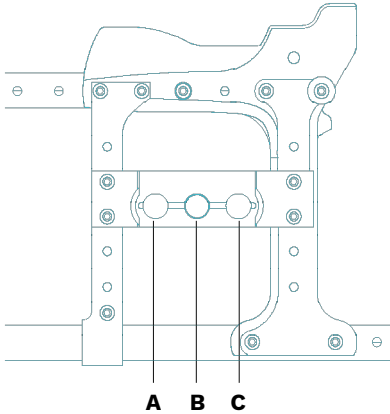

Seat height table for anterior seat height (aSH) [cm]

Caster wheel diameter	Adjustment range	
	Caster fork short	Caster fork long
5"	40 - 44	44 - 47
5,5"	42 - 44	44 - 48
6"	43 - 45	45 - 49
7"	45 - 47	47 - 50
8"	X	48 - 51

A diagram of the seat height adjustment mechanism. It shows a vertical seat post with a seat mounted on top. Four numbered callouts (1, 2, 3, 4) point to different adjustment points on the seat post, likely corresponding to the different wheel sizes listed in the table.

Seat height table for posterior seat height (pSH) [cm]

Free mounting position	Drive wheel size	
	22"	24"
1	38	41
2	41	44
3	44	47
4	47	50

A technical line drawing of the horizontal drive wheel assembly, similar to the one above. Four vertical lines indicate different mounting positions for the drive wheels, labeled 1, 2, 3, and 4 from left to right.

The values indicated are rounded values which have been theoretically determined. Max. deviation of 1 cm.

The anterior seat height depends on the selected wheel size, caster fork and mounting position. Please refer to the seat height table!

Specified without seat cushion at 0° seat inclination.

The maximum possible seat inclination is 3.5 cm.

A manufacturing tolerance of 10 mm applies to all measurements and of 10% to specified weights.

# Lightweight wheelchair *Start<sup>M4</sup> XXL.*

## Frame accessories

<input type="checkbox"/>	MA50	Transport wheels	£63.00
<input type="checkbox"/>	MA57	Crutch holder, right	£31.00
<input type="checkbox"/>	MA58	Crutch holder, left	£31.00
<input type="checkbox"/>	MA61	Swinging anti-tipper, right	£51.00
<input type="checkbox"/>	MA62	Swinging anti-tipper, left	£51.00

## Caster wheels

### Dimensions [cm]

<input type="radio"/>	MF03	5" solid rubber	130 x 33	Inclusive
<input type="radio"/>	MF04	5,5" soft	140 x 40	Inclusive
<input type="radio"/>	MF06	6" solid rubber	150 x 27	Inclusive
<input type="radio"/>	MF07	7" pneumatic	180 x 45	Inclusive
<input type="radio"/>	MF08	7" solid rubber	180 x 45	Inclusive
<input type="radio"/>	MF09	8" pneumatic, narrow (long caster fork required)	200 x 30	Inclusive
<input type="radio"/>	MF12	8" pneumatic, wide (long caster fork required)	200 x 50	Inclusive
<input type="radio"/>	MF10	8" solid rubber, narrow (long caster fork requires)	200 x 30	Inclusive
<input type="radio"/>	MF13	8" PU tyres, wide (long caster fork required)	200 x 50	Inclusive

## Caster forksLenkradgabeln

<input type="radio"/>	MF80	Caster fork long	Inclusive
<input type="radio"/>	MF81	Caster fork short	Inclusive

## Drive wheel size

<input type="radio"/>	MG01	22"	Inclusive
<input type="radio"/>	MG02	24"	Inclusive

## Horizontal drive wheel position

A     B     C

## Drive wheel rim

<input type="radio"/>	MG05	Standard	Inclusive
<input type="radio"/>	MG80	Rear wheel with drum brake for attendant	£385.00

## Tyres

<input type="radio"/>	MG30	Pneumatic 1 3/8"	Inclusive
<input type="radio"/>	MG35	PU 1 3/8"	Inclusive

## Handrims

<input type="radio"/>	MG52	Aluminium, silver anodised, high	Inclusive
<input type="radio"/>	MG56	Stainless steel, polished, high	£60.00

## Drive wheel accessories

<input type="checkbox"/>	MG87	High-pressure air pump, 14 bar	£117.00
<input type="checkbox"/>	MG88	Airman pump	£179.00
<input type="checkbox"/>	MG84	Handrimcover silicone	£117.00

## Wheel lock

<input type="radio"/>	MH01	Knee lever wheel lock Standard	Inclusive
<input type="radio"/>	MH06	Knee lever wheel lock for user and attendant	£250.00

## Lightweight wheelchair *Start<sup>M4</sup> XXL.*

### Wheel lock accessories

<input type="radio"/> MH10	Plug-on wheel lock lever extension	£31.00
----------------------------	------------------------------------	--------

### Back support height in cm

<input type="radio"/> 40	<input type="radio"/> 42,5	<input type="radio"/> 45	<input type="radio"/> 47,5
--------------------------	----------------------------	--------------------------	----------------------------

### Back support upholstery

<input type="radio"/> MD04	Standard	Inclusive
<input type="radio"/> MD05	Adaptable	£95.00
<input type="radio"/> MD06	Without	Inclusive

### Push handles

<input type="radio"/> MD51	Standard	Inclusive
<input type="radio"/> MD52	Telescoping	£208.00

### Back support accessories

<input type="radio"/> MD58	Stabiliser bar for push handles	£49.00
----------------------------	---------------------------------	--------

### Side panels

<input type="radio"/> ME01	Standard, arm pad 300 mm	Inclusive
<input type="radio"/> ME03	Plug-on	Inclusive
<input type="radio"/> ME05	Height-adjustable, arm pad 300 mm	£137.00
<input type="radio"/> ME06	Standard, arm pad 365 mm	£22.00
<input type="radio"/> ME10	Desk side panel, stepped	Inclusive

### Side panel accessories

<input type="checkbox"/> ME60	Therapy tray	£194.00
-------------------------------	--------------	---------

### Seat upholstery

<input type="radio"/> MC13	Standard	Inclusive
<input type="radio"/> MC06	Without	Inclusive

### Sitzkissen

<input type="radio"/> MC01	Standard (functional height 5 cm)	£41.00
<input type="radio"/> MC02	Cubic Foam (functional height 5 cm)	£146.00
<input type="radio"/> MC05	EvoLight (functional height 6 cm)	£208.00
<input type="radio"/> MC29	Livo (functional height 5 cm, max. user weight 125 kg)	£85.00
<input type="radio"/> MC30	EvoFlair (functional height 5 cm)	£303.00

### Lower leg length in cm (without seat cushion)

Lower leg length (LLL) in cm  (available adjustment range 27 cm - 47 cm)

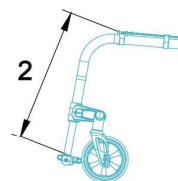

## Lightweight wheelchair *Start<sup>M4</sup> XXL.*

### Leg supports

<input type="radio"/>	MB10	Individual leg supports, angle-adjustable, plastic foot plates	Inclusive
<input type="radio"/>	MB03	Single-panel leg support, angle-adjustable, aluminium	£137.00
<input type="radio"/>	MB25	Elevating leg supports without automatic length adjustment (pair, max. user weight 125 kg)	£250.00
<input type="radio"/>	MB26	Elevating leg support without automatic length adjustment, right (plus standard leg support left, max. user weight 125 kg)	£126.00
<input type="radio"/>	MB27	Elevating leg support without automatic length adjustment, left (plus standard leg support right, max. user weight 125 kg)	£126.00
<input type="radio"/>	MB21	Transtibial residual limb support, right (plus standard leg support left, max. user weight 125 kg)	£126.00
<input type="radio"/>	MB22	Transtibial residual limb support, left (plus standard leg support right, max. user weight 125 kg)	£126.00
<input type="radio"/>	MB23	Transtibial residual limb support, pair (max. user weight 125 kg)	£250.00

### Leg support bar options

<input type="radio"/>	MD40	Short (27 cm - 40 cm)	
<input type="radio"/>	MD41	Medium (32 cm - 47 cm)	Inclusive
<input type="radio"/>	MD42	Long (42 cm - 47 cm)	Inclusive
		Please note that the lower leg lengths vary in case of elevating leg supports.	Inclusive

### Leg support accessories

<input type="checkbox"/>	MB72	Heel strap for individual leg supports	£32.00
--------------------------	------	--	--------

### Other accessories

<input type="checkbox"/>	MZ51	Lap belt with metal buckle	£80.00
<input type="checkbox"/>	MZ52	Tool kit	£63.00
<input type="checkbox"/>	MZ54	Clinical installation kit for head support (max. user weight 125 kg)	£122.00
<input type="checkbox"/>	MZ55	Head support installation kit, multi-axis, offset (max. user weight 125 kg)	£123.00
<input type="checkbox"/>	MZ53	Head support (max. user weight 125 kg)	£107.00

Note: Please also use the order form for wheelchair accessories 647F661.

### Spoke protector

<input type="radio"/>	MG90	Transparent	£150.00
<input type="radio"/>	MG95	Motiv Dekor	£240.00

### Frame colours

<input type="radio"/>	002	Anthrazit metallic	Inclusive
<input type="radio"/>	003	Jet black RAL 9005	Inclusive
<input type="radio"/>	016	Silver metallic	Inclusive

**Lightweight wheelchair *Start<sup>M4</sup> XXL.***

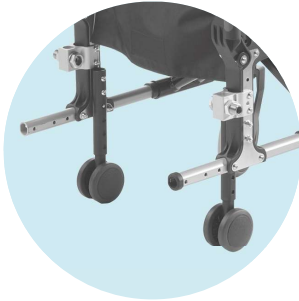

**MA50 Transport wheels**



**MA57/58 Crutch holder**



**MA62 Swinging anti-tipper**



**MG87 High pressure air pump**



**MG88 Airman pump**

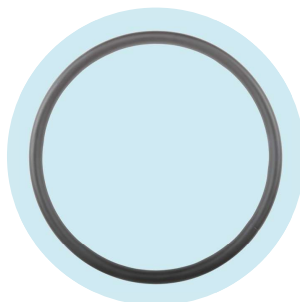

**MG84 Handrim cover silicone**



**MH01 Knee lever wheel lock Standard**

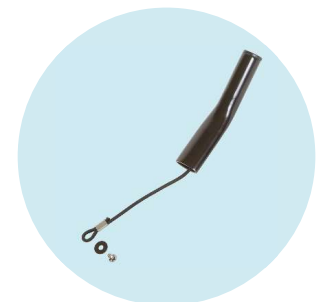

**MH10 Plug-on wheel lock lever extension**



**MD51 Push handles Standard**



**MD52 Push handles telescoping**



**MD58 Stabiliser bar**



**ME01/06 Side panel Standard with arm pad**



**ME03 Plug-on side panel**



**ME05 Side panel height-adjustable with arm pad**

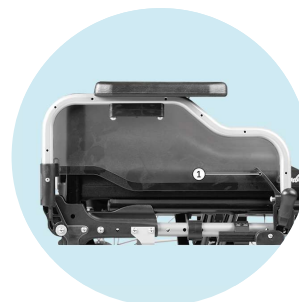

**ME10 Desk side panel, step-ped**

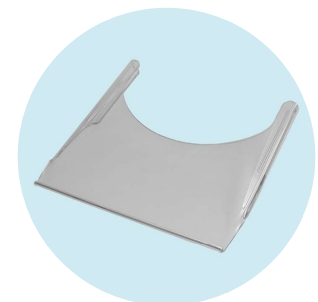

**ME60 Therapy tray**

**Lightweight wheelchair *Start<sup>M4</sup> XXL.***

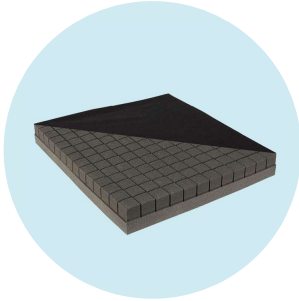

**MC02 Cubic Foam**

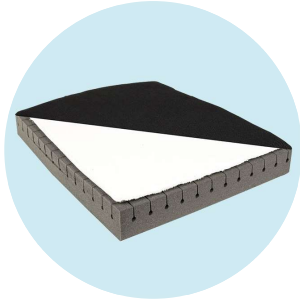

**MC05 Evolight**



**MC29 Livo**

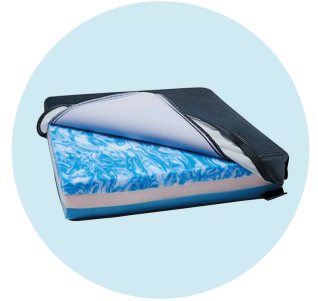

**MC30 EvoFlair**



**MB10 Individual leg supports, plastic foot plates**

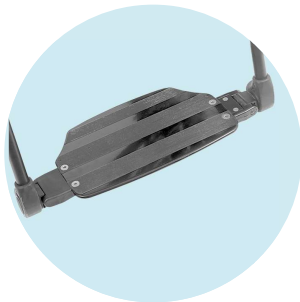

**MB03 Single-panel leg support, aluminium**



**MB25/26/27 Elevating leg support**



**MB21/22/33 Transtibial residual limb support**



**MB72 Heel strap**



**MB51 Lap belt with metal buckle**



**MB52 Tool kit**

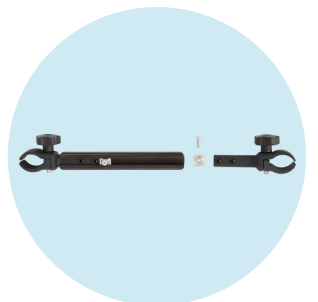

**MZ54 Clinical installation kit for head support**



**MZ55 Head support installation kit, multi-axis**



**MZ53 Head support**

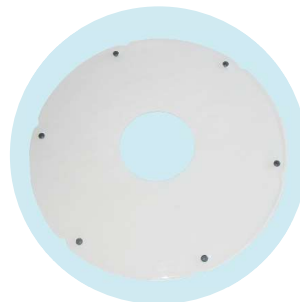

**MG80 Transparent**

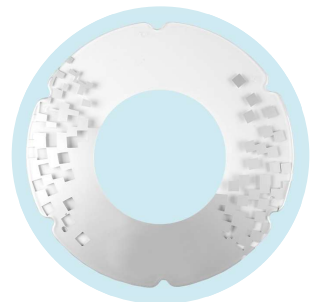

**MG95 Decor**